

MU20H Series

20W, Wide 4:1 Input, 1.5KV Isolation, DIP2"x1" DC/DC Converters



Features

- Rated power: 20W Max
- Input voltage range 4:1
- Regulated output with 10% trimming range
- High efficiency up to 90%
- Isolation voltage 1.5KVDC
- Remote On/Off control
- Operating temperature range: -40 ~ +85°C ambient
- RoHS compliant
- Standard 2"x1" package
- Six-sided metal shielding package
- Under voltage, over voltage, over current, and short circuit protection
- Designed to meet UL/EN/IEC 62368-1
- 3 year warranty



Overview

The MU20H series are 1.5KV isolated 20Watt DC/DC converters with standard DIP2"x1" footprint. Designed with high efficiency, they operate in a wide temperature range from -40°C to +85°C. Other features include wide 4:1 input voltage range, remote on/off control, output trimming, under voltage, over voltage, over current, and short circuit protections. These converters are ideally suitable for industrial control system, measurement equipment, telecom, wireless network.

Model Numbers

Model Number	Input Voltage [VDC]			V _{OUT} [VDC]	Output Current [mA]		Efficiency [%] Typ.	Capacitive Load [uF] Max.
	Nom.	Range	*Max.		Max.	Min.		
MU20H-2403	24	9~36	40	3.3	5000	0	86	10000
MU20H-2405	24	9~36	40	5	4000	0	88	10000
MU20H-2409	24	9~36	40	9	2222	0	89	4700
MU20H-2412	24	9~36	40	12	1667	0	89	1600
MU20H-2415	24	9~36	40	15	1333	0	90	1000
MU20H-2424	24	9~36	40	24	834	0	90	500
MU20H-2405D	24	9~36	40	±5	±2000	0	86	4800
MU20H-2409D	24	9~36	40	±9	±1111	0	88	1000
MU20H-2412D	24	9~36	40	±12	±834	0	88	800
MU20H-2415D	24	9~36	40	±15	±667	0	88	625
MU20H-4803	48	18~75	80	3.3	5000	0	86	10000
MU20H-4805	48	18~75	80	5	4000	0	86	10000
MU20H-4809	48	18~75	80	9	2222	0	89	4700
MU20H-4812	48	18~75	80	12	1667	0	87	1600
MU20H-4815	48	18~75	80	15	1333	0	90	1000

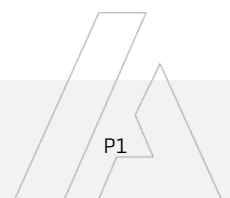

MU20H Series

20W, Wide 4:1 Input, 1.5KV Isolation, DIP2"X1" DC/DC Converters



Model Numbers [continued]

Model Number	Input Voltage [VDC]			V _{OUT} [VDC]	Output Current [mA]		Efficiency [%] Typ.	Capacitive Load [uF] Max.
	Nom.	Range	*Max.		Max.	Min.		
MU20H-4824	48	18~75	80	24	834	0	88	500
MU20H-4805D	48	18~75	80	±5	±2000	0	86	4800
MU20H-4812D	48	18~75	80	±12	±834	0	88	800
MU20H-4815D	48	18~75	80	±15	±667	0	89	625

* Input voltage exceed the Max. value may cause permanent damage.

* Only typical models are listed. Other models may be available upon request.

Electrical Specifications

Unless otherwise indicated, specifications are measured at T_A=25°C, nominal input voltage, full load after warm up.

Parameters	Conditions	Min.	Typ.	Max.	Unit	Note
Input current Full load, V _{IN, Nom} =24V	V _{OUT} =3.3V V _{OUT} =5V Others	-	799 969 947	-	mA	
Input current Full load, V _{IN, Nom} =48V	V _{OUT} =3.3V V _{OUT} =5V Others		400 485 474	-	mA	
Input current No load	V _{IN, Nom} =24V V _{IN, Nom} =48V		40 20	-	mA	
Reflected ripple current		-	30	-	mA	
Input voltage surge 1 second max	V _{IN, Nom} =24V V _{IN, Nom} =48V	-0.7 -0.7	-	50 100	VDC	
Startup input voltage	V _{IN, Nom} =24V V _{IN, Nom} =48V	-	-	9 18	VDC	
Startup time	Resistive load	-	10	-	mS	
Input under voltage shutdown	V _{IN, Nom} =24V V _{IN, Nom} =48V	5.5 12	6.5 15.5	-	VDC	
Remote On/Off control "Ctrl" pin open or logic high [ON] "Ctrl" pin grounded or logic low [OFF]	Logic high Logic low Ctrl pin current	3.5 0 -	- - 4	12 1.2 7	VDC VDC mA	Positive Logic

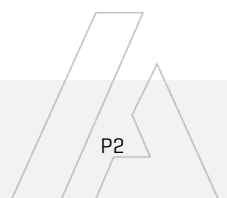

Electrical Specifications [continued]

Parameters	Conditions	Min.	Typ.	Max.	Unit	Note
Output voltage accuracy	$I_{OUT}=0\%$ to 100%	-	± 1	± 3	%	
Line regulation Full load, $V_{IN}=V_{IN, Min}$ to $V_{IN, Max}$	Main output	-	± 0.2	± 0.5	%	
	Other output	-	± 0.5	± 1.0	%	
Load regulation $I_{OUT}=5\%$ to 100% of $I_{OUT, rated}$	Main output	-	± 0.5	± 1.0	%	
	Other output	-	± 0.5	± 1.5	%	
Cross regulation $+I_{OUT}=50\%$, $-I_{OUT}=10\%$ to 100%	Dual output models	-	-	± 5	%	
Output ripple and noise 20MHz bandwidth, peak to peak		-	50	100	mVp-p	
Temperature coefficient	Full load	-	-	± 0.03	%/°C	
Dynamic load response $I_{OUT}=25\% \sim 50\% \sim 75\%$ of $I_{OUT, rated}$	Peak deviation**	-	± 5	± 8	% V_{OUT}	** $V_{OUT}=3.3, 5, \pm 5V$
	Peak deviation		± 3	± 5	% V_{OUT}	
	Recovery time		300	500	μS	
Output voltage trim	Trim range	-	-	± 10	% V_{OUT}	
Output over voltage protection		110	-	160	% V_{OUT}	
Output over current protection		110	-	190	% I_{OUT}	
Output short circuit protection		Continuous, automatic recovery				
Input filter		PI filter				
Hot plug		None				

* Operating with less than 5% of rated load will not cause damage to the converters, but the performances data may not fall into the specifications, and stable operating is not assured.

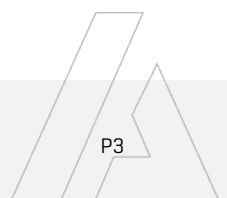

MU20H Series

20W, Wide 4:1 Input, 1.5KV Isolation, DIP2"X1" DC/DC Converters



General Specifications

Parameters	Conditions	Min.	Typ.	Max.	Unit	Note
Isolation voltage 1 minute, leakage current 1mA max.	I/P to O/P	1500	-	-	VDC	
Isolation resistance Tested at 500VDC	I/P to O/P	1000	-	-	M ohm	
Isolation capacitance 100KHz, 0.1V, I/P to O/P	MU20H-2424 Others	-	2050 1050	-	pF	
Switching frequency*	Full load	-	270	-	KHz	PWM mode
Operating temperature	See "Derating Curve"	-40	-	+85	°C	
Storage temperature		-55	-	+125	°C	
Storage humidity	None condensing	5	-	95	%RH	
Pin soldering resistance 1.5mm away from case for 10 sec		-	-	300	°C	
Vibration		IEC/EN61373 - Category 1, Grade B				
Cooling method		Free air convection				
Case material		Aluminum alloy				
MTBF	MIL-HDBK-217F	>1,000,000 Hours, T _A =25°C				
Design based on standards		UL/EN/IEC 62368-1				
Safety certifications		EN 62368-1, UL/IEC 60950-1				
EMC		CISPR32, EN55032 Class B with external circuit IEC/EN61000-4-2, 3, 4, 5, 6				
Size, and Weight		50.8 x 25.4 x 12 mm, 28g				

* Switching frequency is measured at full load. The converter reduces the switching frequency at low load [less than 50% load] for better efficiency.

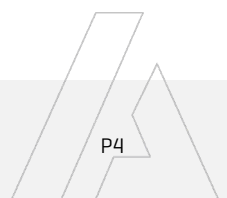

MU20H Series

20W, Wide 4:1 Input, 1.5KV Isolation, DIP2"X1" DC/DC Converters



Characteristic Curves

Derating Curve

Output vs Ambient Temperature

No heatsink

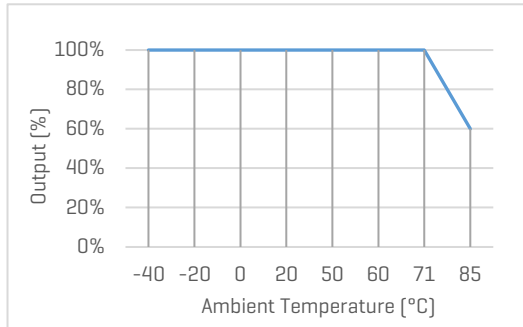

Efficiency Curve

Efficiency vs Input Voltage

MU20H-2405, with full Load

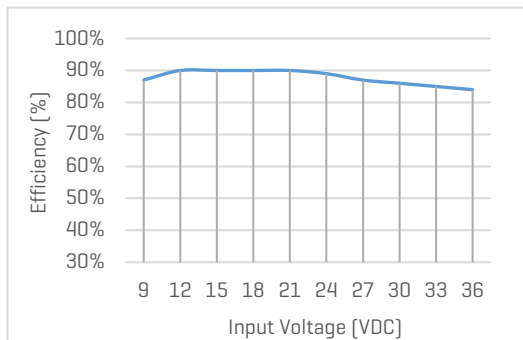

Efficiency vs Load

MU20H-2405, with nominal input voltage

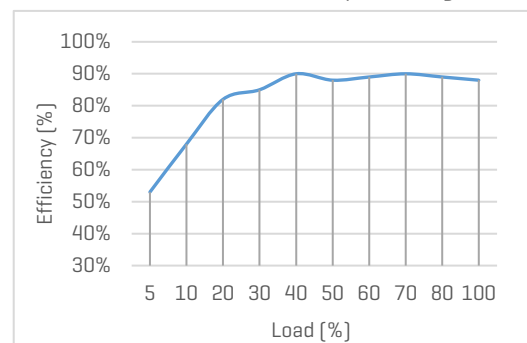

MU20H-4815D, with full Load

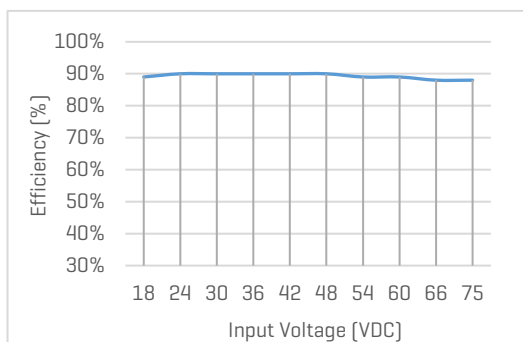

MU20H-4815D, with nominal input voltage

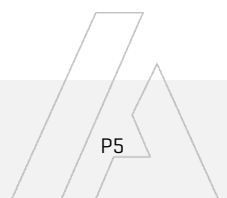
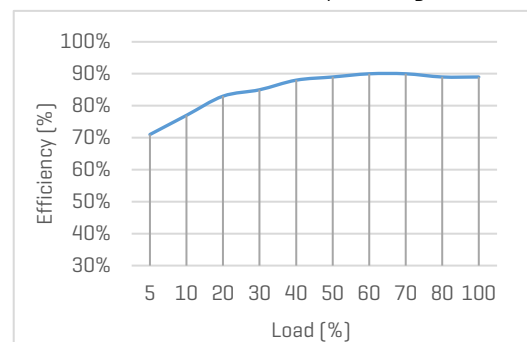

Recommended Application Circuit

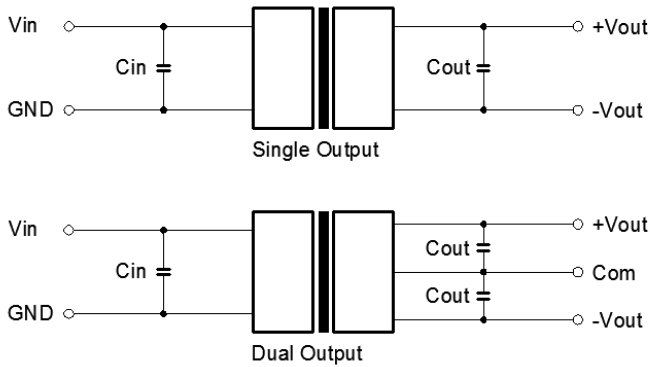

Note

*Typical application circuit is to further lower the input and output ripple. It is not required for general use.
 *Recommended component specifications are typical values. Excessive external capacitive load may cause startup problem.

Figure 1. Typical external circuit

[Table 1] Recommended component spec

Input voltage	24V	48V
C _{IN}	100uF, 50V	100uF, 100V

[Table 2] Recommended component spec

Output voltage	3.3, 5V	9 ... 15V	24V	±5V	±9 ... ±15V
C _{OUT}	470uF, 16V	220uF, 25V	100uF, 50V	220uF, 16V	100uF, 25V

Circuit for EMC Enhancement

*Use this application circuit to meet Class B EMC performance.

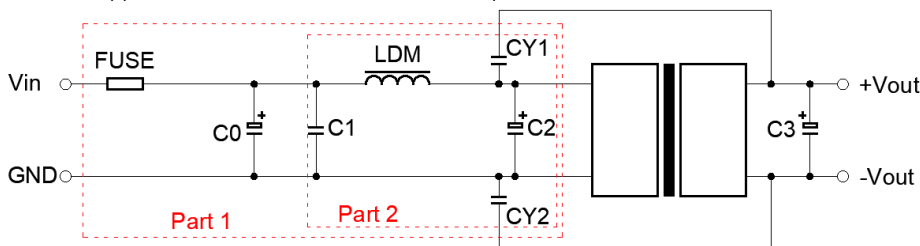

Figure 2. Circuit for EMC enhancement

[Table 3] Recommended component spec

Component	LDM	C0, C2	C1	CY1, CY2
V _{IN} =24V	4.7uH	330uF, 50V	1uF, 50V	1nF, 2KV
V _{IN} =48V	3.3uH	330uF, 100V	1uF, 100V	1nF, 2KV

* Fuse to be selected according to application needs.

* C3 refer to relative C_{OUT} values in Table 2.

Recommended Application Circuit [continued]

Circuits for Output Trim

* Components within the red block are internal components of the converter.

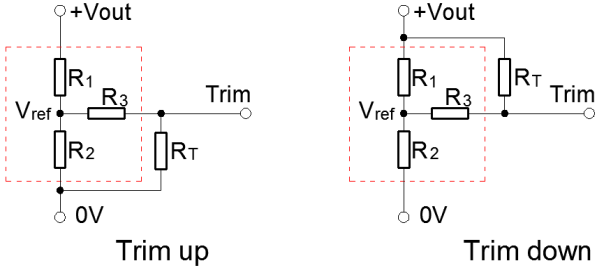

[Table 4] Internal Component Spec

V _{OUT} [V]	R1 [K Ohm]	R2 [K Ohm]	R3 [K Ohm]	V _{ref} [V]
3.3	4.80	2.87	12.4	1.25
5	2.88	2.87	10	2.5
9	7.50	2.87	15	2.5
12	11.00	2.87	15	2.5
15	14.95	2.87	15	2.5
24	24.87	2.87	17.8	2.5

* The formulas to calculate the desired resistance of Trim resistor "R_T".

$$\text{Trim up: } R_T = \frac{a R_2}{R_2 - a} - R_3 \quad a = \frac{V_{ref}}{V_{OUT} - V_{ref}} R_1$$

$$\text{Trim down: } R_T = \frac{a R_1}{R_1 - a} - R_3 \quad a = \frac{V_{OUT} - V_{ref}}{V_{ref}} R_2$$

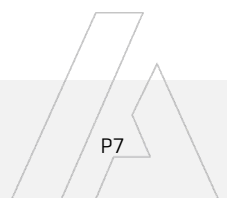

MU20H Series

20W, Wide 4:1 Input, 1.5KV Isolation, DIP2"x1" DC/DC Converters



Mechanical Specifications

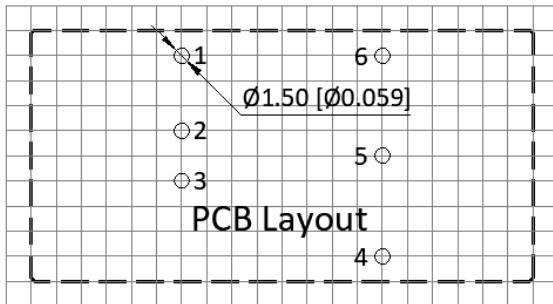
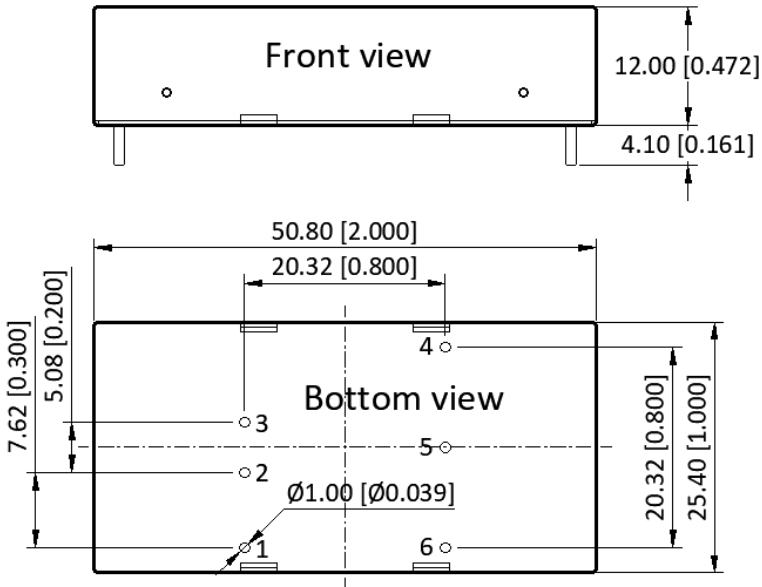

Pin Definition

Pin #	Single Out	Dual Out
1	Ctrl	Ctrl
2	GND	GND
3	V _{IN}	V _{IN}
4	+V _{OUT}	+V _{OUT}
5	Trim	0V
6	0V	-V _{OUT}

* Unless otherwise specified unit: mm [inch]

* General tolerance: ±0.50 [±0.020]

* Pin thickness: ±0.10 [±0.004]

* Footprint grid 2.54 x 2.54 mm

