

MRK1T Series

1W, Regulated Output, 3KV Isolation, SMD DC/DC Converters



Features

- Rated power: 1W Max
- Input voltage range $\pm 5\%$
- Regulated single output
- High efficiency up to 71%
- Isolation voltage 3KVDC
- Operating temperature range: $-40 \sim +85^{\circ}\text{C}$ ambient
- No external components required for operating
- RoHS compliant
- Industrial standard SMD package
- Continuous short circuit protection
- Meet EN/IEC 62368-1
- 3 year warranty



Overview

The MRK1T series are SMD package DC/DC converters with tightly regulated single output, and 3KVDC isolation. These converters feature high efficiency, low ripple and noise, short circuit protection, and wide operating temperature range. They are widely used in distributed power system in industrial applications where isolation and voltage converting is needed.

Model Numbers

Model Number	Input Voltage [VDC] $\pm 5\%$	Output Voltage [VDC]	Output Current [mA]		Efficiency [%] Typ.	Capacitive Load [μF] Max.
			Max.	Min.		
MRK1T-0503	5	3.3	250	25	66	2400
MRK1T-0505	5	5	200	20	69	2400
MRK1T-0509	5	9	111	12	70	1000
MRK1T-0512	5	12	84	9	71	560
MRK1T-0515	5	15	67	7	71	560
MRK1T-0524	5	24	41	4	71	100
MRK1T-1205	12	5	200	20	69	2400
MRK1T-1212	12	12	84	9	71	560
MRK1T-1215	12	15	67	7	71	220
MRK1T-1505	15	5	200	20	68	2400
MRK1T-2405	24	5	200	20	69	2400
MRK1T-2412	24	12	84	9	71	560
MRK1T-2415	24	15	67	7	71	220

* Only typical models are listed. Other models may be available upon request.

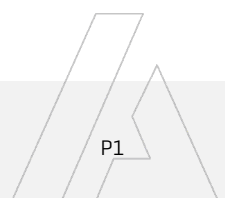

MRK1T Series

1W, Regulated Output, 3KV Isolation, SMD DC/DC Converters



Electrical Specifications

Unless otherwise indicated, specifications are measured at $T_A=25^{\circ}\text{C}$, nominal input voltage, full load after warm up.

Parameters	Conditions	Min.	Typ.	Max.	Unit	Note
Input current Full load	$V_{IN}=5\text{V}$ $V_{IN}=12\text{V}$ $V_{IN}=15\text{V}$ $V_{IN}=24\text{V}$	-	290 120 100 60	-	mA	
Input current No load		-	6	-	mA	
Reflected ripple current		-	30	-	mA	
Output voltage accuracy		-	-	± 3	%	
Line regulation For V_{IN} change of $\pm 1\%$		-	-	± 0.25	%	
Load regulation $I_{OUT}=10\%$ to 100% of $I_{OUT, rated}$	$V_{OUT}=3.3\text{V}$ Others	-	-	± 3 ± 2	%	
Output ripple and noise 20MHz bandwidth		-	30	100	mVp-p	
Temperature coefficient	Full load	-	± 0.02	-	%/ $^{\circ}\text{C}$	
Output short circuit protection		Continuous, automatic recovery				
Input filter		Capacitor				
Hot plug		None				

* Operating with less than 10% of rated load will not cause permanent damage to the converters, but the performances data may not fall into the specifications, and reliable operating is not assured.

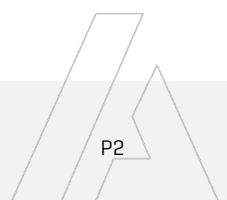

MRK1T Series

1W, Regulated Output, 3KV Isolation, SMD DC/DC Converters



General Specifications

Parameters	Conditions	Min.	Typ.	Max.	Unit	Note
Isolation voltage 1 minute, leakage current 1mA max	Input to Output	3000	-	-	VDC	
Isolation resistance 500VDC	Input to Output	1000	-	-	M ohm	
Isolation capacitance 100KHz, 0.1V	Input to Output	-	20	-	pF	
Operating temperature	See "Derating Curve"	-40	-	+85	°C	
Storage temperature		-55	-	+125	°C	
Temperature rise at full load		-	25	-	°C	
Storage humidity		5	-	95	%RH	
Switching frequency	Full load	-	260	-	KHz	
Reflow soldering temperature		Peak temp. 217 - 245°C, maximum duration 60s				
Vibration		10-150Hz, 5G, 0.75mm along X, Y and Z				
Case material		Black plastic UL94-V0				
Cooling method		Free air convection				
Design based on standards		UL/EN/IEC 62368-1				
Safety certifications		EN/IEC 62368-1				
EMC	Emissions Immunity	CISPR32, EN55032 Class B* IEC/EN61000-4-2, Air ±8KV, Contact ±4KV, Criteria B				
MTBF	MIL-HDBK-217F	>3,500,000 Hours, T _A =25°C				
Moisture sensitivity level [MSL]		IPC/JEDEC J-STD-020D.1 Level 1				
Size & Weight		15.24 x 11.4 x 7.25 mm, 1.5g Typ.				

Characteristic Curves

Derating Curve

Output vs Ambient Temperature

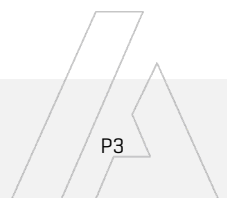
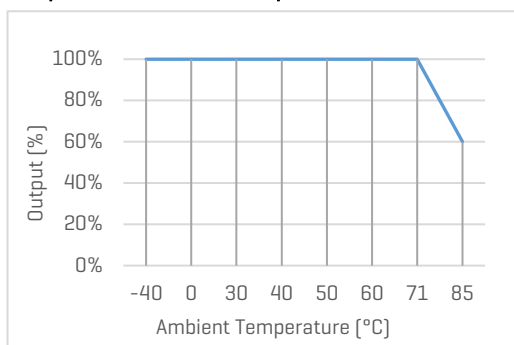

Recommended External Circuit

Typical Application Circuit

*Typical application circuit is to further lower the input and output ripple. It is not required for general use.

*Recommended component specifications are typical values. Excessive external capacitive load may cause startup problem.



Figure 1. Typical external circuit

[Table 1] Recommended component spec

Input voltage	5V	12V	15V	24V
C _{IN}	4.7uF, 25V	2.2uF, 16V	1uF, 25V	1uF, 50V

[Table 2] Recommended component spec

Output voltage	3.3, 5V	9, 12V	15, 24V
C _{OUT}	10uF, 16V	2.2uF, 25V	1uF, 50V

Circuit for EMC Enhancement

*Use this application circuit to meet Class B EMC performance.

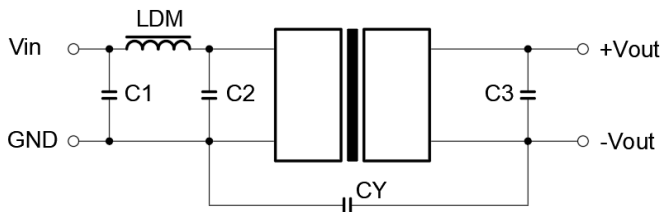

Figure 2. Circuit for EMC enhancement

[Table 3] Recommended component spec

Component	LDM	C1, C2	CY
Spec	6.8uH	4.7uF, 50V	270pF, 3KV

*C3 refer to C_{OUT} in [Table 2]

MRK1T Series

1W, Regulated Output, 3KV Isolation, SMD DC/DC Converters



Mechanical Specifications

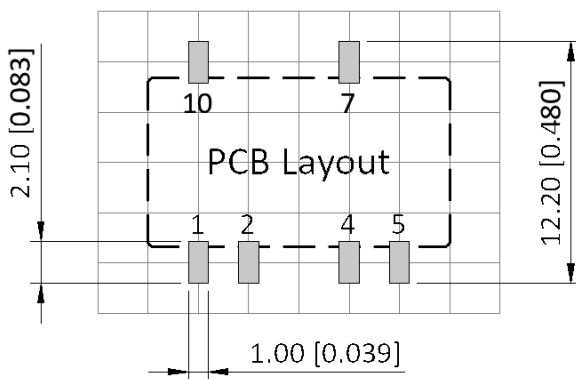
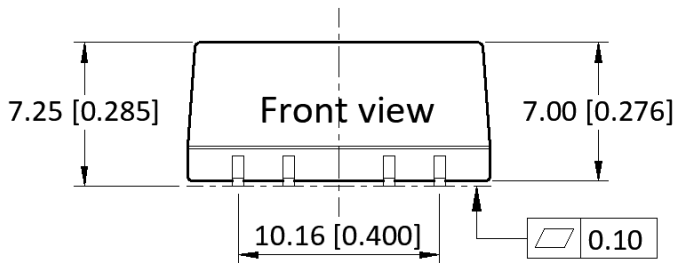
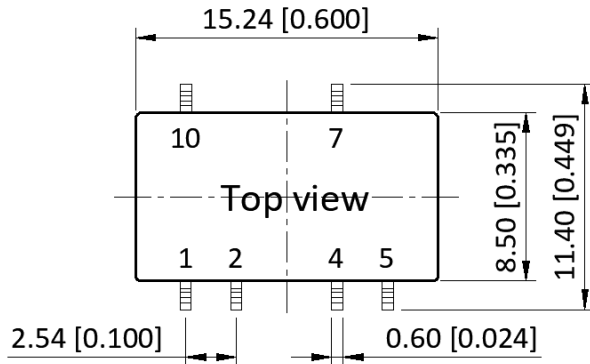

Pin Definition

Pin #	Single Out
1	GND
2	V _{IN}
4, 5	0V
7	+V _{OUT}
10	No Connection

* Unless otherwise specified unit: mm [inch]

* General tolerance: ± 0.25 [± 0.010]

* Pin thickness: ± 0.10 [± 0.004]

* Footprint grid 2.54 x 2.54 mm

