

ME1D Series

1W, Unregulated, 1.5KV Isolation, DIP14 Package DC/DC Converters



Features

- Rated power: 1W Max
- Input voltage range $\pm 10\%$
- Unregulated single or dual output
- High efficiency, up to 89%
- Small no load input current
- Isolation voltage 1.5KVDC
- Operating temperature range: $-40 \sim +105^{\circ}\text{C}$ ambient
- RoHS compliant
- Standard DIP14 package
- Continuous short circuit protection
- Designed to meet UL/EN/IEC 62368-1
- 3 year warranty

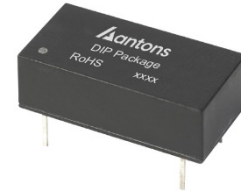

Overview

The ME1D series are DIP14 package DC/DC converters with unregulated single or dual output, and 1.5KVDC isolation. These converters feature high efficiency, low ripple and noise, continuous short circuit protection, and wide operating temperature range. They are widely used in distributed power system in industrial applications where isolation and voltage converting is needed.

Model Numbers

Model Number	Input Voltage [VDC] $\pm 10\%$	Output Voltage [VDC]	Output Current [mA]		Efficiency [%] Typ.	Capacitive Load [μF] Max.
			Max.	Min.		
ME1D-0303	3.3	3.3	303	30	82	4000
ME1D-0305	3.3	5	200	20	83	4000
ME1D-0309	3.3	9	111	11	84	2000
ME1D-0312	3.3	12	84	8	85	1000
ME1D-0503	5	3.3	303	30	83	4000
ME1D-0505	5	5	200	20	86	4000
ME1D-0509	5	9	111	12	86	2000
ME1D-0512	5	12	84	9	88	1000
ME1D-0515	5	15	67	7	88	680
ME1D-0524	5	24	42	4	89	560
ME1D-1203	12	3.3	303	30	84	4000
ME1D-1205	12	5	200	20	86	4000
ME1D-1209	12	9	111	12	87	2000
ME1D-1212	12	12	84	9	87	1000
ME1D-1215	12	15	67	7	88	680
ME1D-1224	12	24	42	4	89	560

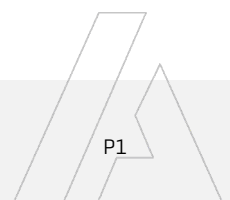

ME1D Series

1W, Unregulated, 1.5KV Isolation, DIP14 Package DC/DC Converters



Model Numbers [continued]

Model Number	Input Voltage [VDC] $\pm 10\%$	Output Voltage [VDC]	Output Current [mA]		Efficiency [%] Typ.	Capacitive Load [μ F] Max.
ME1D-1505	15	5	200	20	86	4000
ME1D-1509	15	9	111	12	87	2000
ME1D-1512	15	12	84	9	87	1000
ME1D-1515	15	15	67	7	88	680
ME1D-2403	24	3.3	303	30	84	4000
ME1D-2405	24	5	200	20	87	4000
ME1D-2409	24	9	111	12	88	2000
ME1D-2412	24	12	84	9	88	1000
ME1D-2415	24	15	67	7	88	680
ME1D-2424	24	24	42	4	89	560
ME1D-0505D	5	± 5	± 100	± 10	86	2000
ME1D-0509D	5	± 9	± 56	± 6	86	1000
ME1D-0512D	5	± 12	± 42	± 5	88	560
ME1D-0515D	5	± 15	± 34	± 4	88	220
ME1D-1203D	12	± 3.3	± 152	± 15	84	2000
ME1D-1205D	12	± 5	± 100	± 10	86	2000
ME1D-1209D	12	± 9	± 56	± 6	87	1000
ME1D-1212D	12	± 12	± 42	± 5	87	560
ME1D-1215D	12	± 15	± 34	± 4	88	220
ME1D-1505D	15	± 5	± 100	± 10	86	2000
ME1D-1512D	15	± 12	± 42	± 5	87	560
ME1D-1515D	15	± 15	± 34	± 4	88	220
ME1D-2405D	24	± 5	± 100	± 10	87	2000
ME1D-2409D	24	± 9	± 56	± 6	88	1000
ME1D-2412D	24	± 12	± 42	± 5	88	560
ME1D-2415D	24	± 15	± 34	± 4	88	220

* Only typical models are listed. Other models may be available upon request.

* For dual output models, max capacitive load stipulated in the above list is for each output.

* See MEK1D series for 3KVDC isolation models.

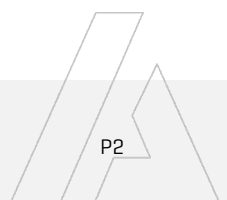

Electrical Specifications

Unless otherwise indicated, specifications are measured at $T_A=25^{\circ}\text{C}$, nominal input voltage, full load after warm up.

Parameters	Conditions	Min.	Typ.	Max.	Unit	Note
Input current Full load	$V_{IN}=3.3\text{V}$		370			
	$V_{IN}=5\text{V}$		230			
	$V_{IN}=12\text{V}$	-	99	-	mA	
	$V_{IN}=15\text{V}$		78			
	$V_{IN}=24\text{V}$		51			
Input current	No load	-	3	15	mA	
Reflected ripple current		-	15	-	mA	
Surge voltage 1 second max	$V_{IN}=3.3\text{V}$	-0.7		5		
	$V_{IN}=5\text{V}$	-0.7		9		
	$V_{IN}=12\text{V}$	-0.7	-	18	VDC	
	$V_{IN}=15\text{V}$	-0.7		21		
	$V_{IN}=24\text{V}$	-0.7		30		
Output voltage accuracy		Refer to graphic in "Characteristic Curves" section				
Line regulation For V_{IN} change of $\pm 1\%$	$V_{OUT}=3.3\text{V}$	-	± 1.5	-	%	
	Other Output		± 1.2			
Load regulation $I_{OUT}=10\%$ to 100% of $I_{OUT, rated}$	$V_{OUT}=3.3\text{V}$		10			
	$V_{OUT}=5\text{V}$		8			
	$V_{OUT}=9\text{V}$		8			
	$V_{OUT}=12\text{V}$	-	7	-	%	
	$V_{OUT}=15\text{V}$		6			
	$V_{OUT}=24\text{V}$		6			
Output ripple and noise	20MHz bandwidth	-	45	100	mVp-p	
Temperature coefficient	Full load	-	± 0.03	-	$\%/^{\circ}\text{C}$	
Output short circuit protection		Continuous, automatic recovery				
Input filter		Capacitor				
Hot plug		None				

* Operating with less than 10% of rated load will not cause permanent damage to the converters, but the performances data may not fall into the specifications, and reliable operating is not assured.

* Dual output models need to operate with balanced load. The load difference between two outputs over 10% may cause unstable operating of the converter.

ME1D Series

1W, Unregulated, 1.5KV Isolation, DIP14 Package DC/DC Converters



General Specifications

Parameters	Conditions	Min.	Typ.	Max.	Unit	Note
Isolation voltage 1 minute, leakage current 1mA max	Input to Output	1500	-	-	VDC	
Isolation resistance Tested at 500VDC	Input to Output	1000	-	-	M ohm	
Isolation capacitance Tested at 100KHz, 0.1V	Input to Output	-	20	-	pF	
Operating temperature	No derating	-40	-	+105	°C	
Storage temperature		-55	-	+125	°C	
Temperature rise at case	Full load	-	25	-	°C	
Storage humidity	Non-condensing	-	-	95	%RH	
Switching frequency	Full load	-	220	-	KHz	
Pin soldering resistance 1.5mm away from case for 10 sec		-	-	300	°C	
Vibration		10-150Hz, 5G, 0.75mm along X, Y and Z				
Case material		Black plastic UL94-V0				
Cooling method		Free air convection				
Design based on standards		UL/EN/IEC 62368-1				
Safety certifications		EN/IEC 62368-1				
EMC	Emissions Immunity	CISPR32, EN55032 Class B* IEC/EN61000-4-2				
MTBF	MIL-HDBK-217F	>3,500,000 Hours, T _A =25°C				
Size		19.5 x 9.8 x 7.9 mm				
Weight		2.4g Typ.				

*External circuit is required in order to meet Class B, refer to Figure 2 in Recommended External Circuit

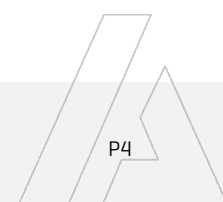

Characteristic Curves

Derating Curve

Output vs Ambient Temperature

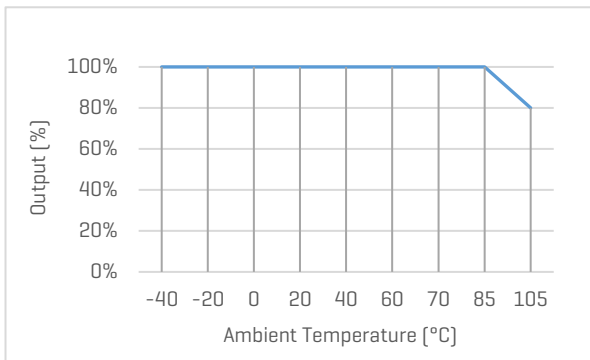

Output Voltage Accuracy vs Load

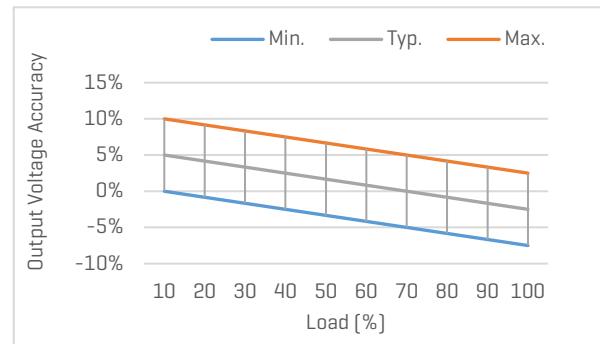

Efficiency Curves

Efficiency vs Input Voltage

ME1D-1205, with full Load

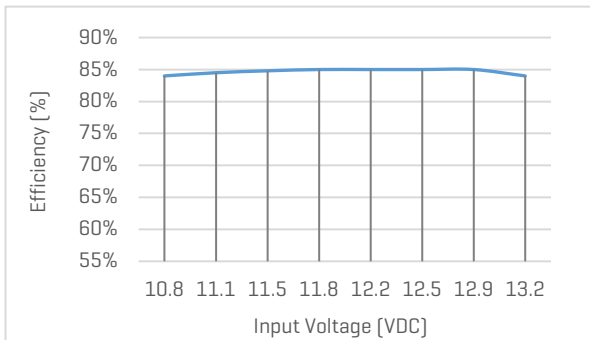

Efficiency vs Load

ME1D-1205, with nominal input voltage

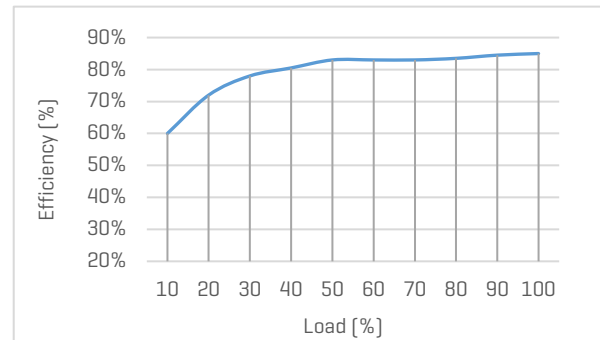

Efficiency vs Input Voltage

ME1D-0505D, with full Load

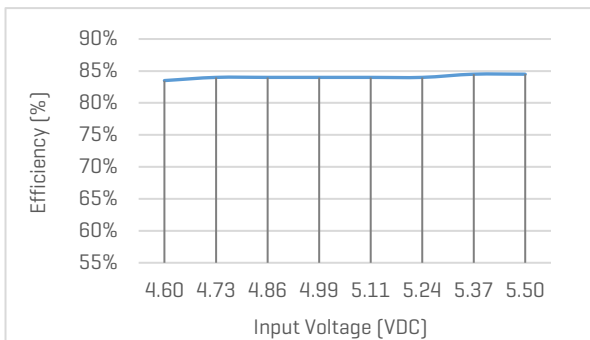

Efficiency vs Load

ME1D-0505D, with nominal input voltage

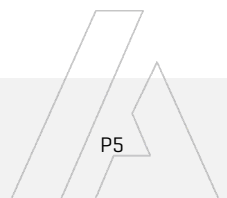
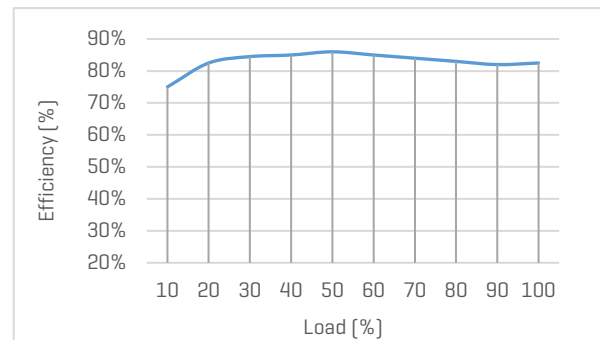

Recommended External Circuit

Typical Application Circuit

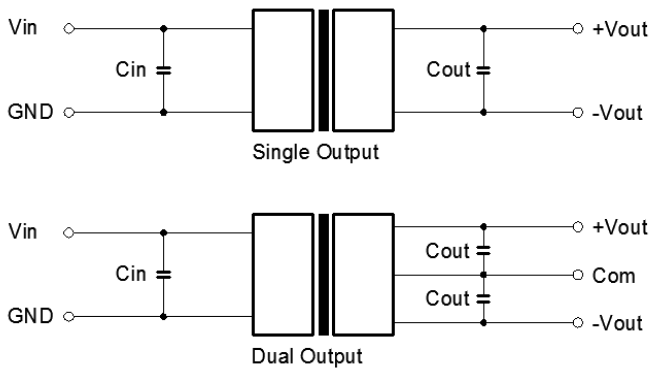

Note

*Typical application circuit is to further lower the input and output ripple. It is not required for general use.

*Recommended component specifications are typical values. Excessive external capacitive load may cause startup problem.

Figure 1. Typical external circuit

[Table 1] Recommended component spec

Input voltage	3.3, 5V	12V	15V	24V
C _{IN}	4.7uF, 16V	2.2uF, 25V	2.2uF, 25V	1.0uF, 50V

[Table 2] Recommended component spec

Output voltage	3.3, 5V	9V	12V	15V	24V
C _{OUT}	10uF, 16V	4.7uF, 16V	2.2uF, 25V	1uF, 25V	0.47uF, 50V

Circuit for EMC Enhancement

*Use this application circuit to meet Class B EMC performance.

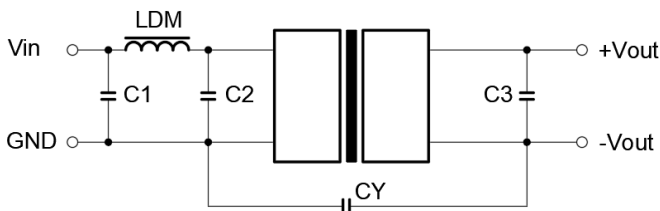

Figure 2. Circuit for EMC enhancement

[Table 3] Recommended component spec

Component	LDM	C1, C2	CY
Spec	6.8uH	4.7uF, 50V	1nF, 2KV

*C3 refer to C_{OUT} in [Table 2]

ME1D Series

1W, Unregulated, 1.5KV Isolation, DIP14 Package DC/DC Converters



Mechanical Specifications

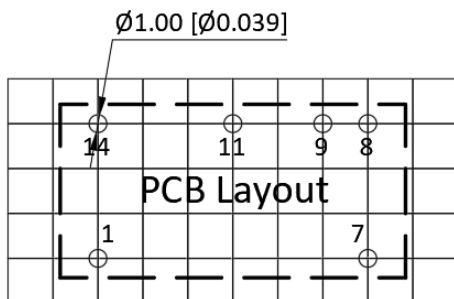
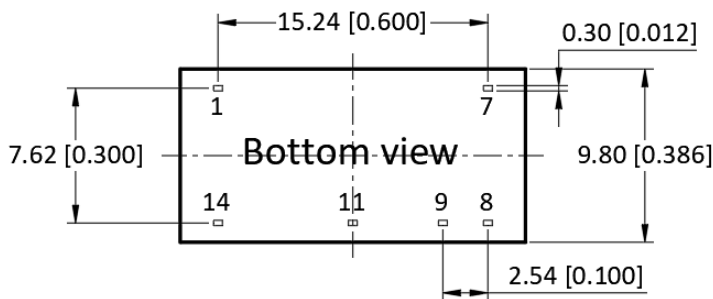
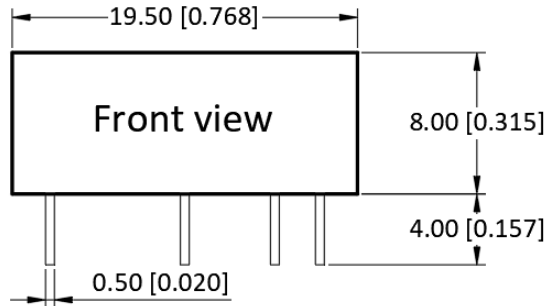

Pin Definition

Pin #	Single Out	Dual Out
1	GND	GND
7	NC	NC
8	-V _{OUT}	0V
9	+V _{OUT}	+V _{OUT}
11	No Pin	-V _{OUT}
14	V _{IN}	V _{IN}

* Unless otherwise specified unit: mm [inch]

* General tolerance: ±0.25 [±0.010]

* Pin thickness: ±0.10 [±0.004]

* Footprint grid 2.54 x 2.54 mm

